



Has a long history of accurately measuring shocks that occur during product transportation. For over 40 years, manufacturers and the military have used our well designed and reliable recorders to warn recipients when mishandling has occurred to valuable shipments.

- Well designed, reliable and simple.
- Charts magnitude, direction and time of impact.
- Records continuously for up to 6 months.
- Standard C Cell battery.
- Shocks up to 30 times the force of gravity (30g) can be identified immediately by examining the chart.
- Deter and detect mishandling.
- Accepted as evidence in legal liability disputes.
- Self-contained, no additional equipment is needed.

***Chart paper and warning label are available.**

How Our Impact Recorders Work

Three mass-spring styluses work independently of each other, each measuring one axis- X, Y and Z. Each stylus operates by angular vibration with one degree of freedom in the direction it monitors. The mechanical, friction-free linkage from each stylus' inertia mass converts motion from any of the three directions into the same plane and draws these forces onto the chart paper for easy reading.

Impact-O-Graph Devices has a complete line of products for your transportation monitoring needs.

Visit us at: www.impactograph.com

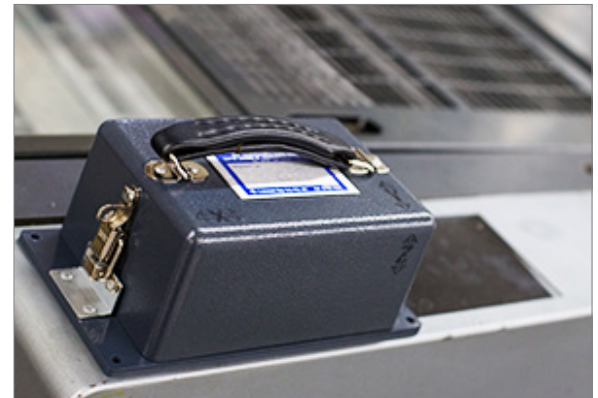
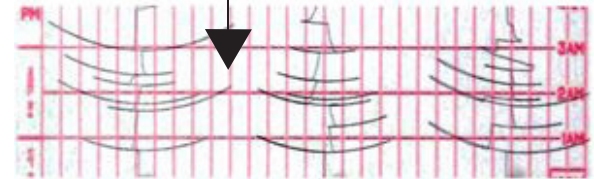
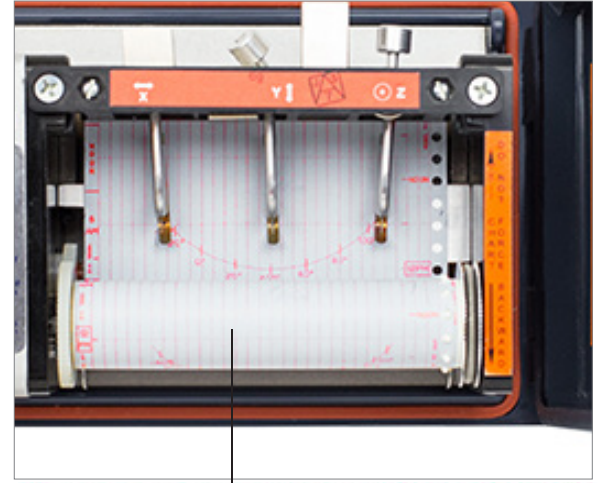

Easy Installation and Operation

Impact-O-Graph Recorders are delivered ready to use with paper and battery already installed (no ink is used). An Operations Manual is provided with each recorder.

1. Mount the Impact Recorder securely to the object to be monitored.
2. Remove the stylus guard and set the chart paper to the starting time.
3. Turn the recorder on. Lock the cover if desired. The recorder is ready to document impacts on pressure sensitive paper.

Date: 10/24/19

Impact-O-Graph Models

Model	Chart Speed	Metric	Chart Life	Battery Life
M-4	1/2 in/hour	1.27 cm/hour	40 days	6 months
M-3	1/4 in/hour	6.35 cm/hour	80 days	6 months
M-2	3 in/day	7.62 cm/day	160 days	6 months
M-1	2 in/day	5.08 cm/day	240 days	6 months

Specifications

Model M Recorder	Information
Dimensions	9 1/2 x 5 1/8 x 3 3/4"
Weight	4lbs 1.8 Kilo
Shipping Weight	5lbs 2.3 Kilo
Temperature	-20F to + 220F -29C to + 104C
Case Materials	Poly Carbonate

All recorders come with a rugged housing. A watertight housing or viewing window are available. Rental options are available in North America.

Stylus Brackets Available

Gs	Natural Frequency (fn, cps)	Critical Pulse Duration (milliseconds)
0 to 2*	8.5	58.8
0 to 4*	10.0	50.0
0 to 6	12.5	40.0
0 to 10	15.8	31.6
0 to 15	19.5	25.6
0 to 20	17.6	28.4
0 to 30	23.0	21.8

*Special Bracket (added cost)

Stylus Bracket Settings

The three bracket styli can be ordererd with the same or different g-levels, for example: 2x, 15y, 6z. The appropriate g-level will depend on several factors including product sensitivities, mode of transport, and packaging.

g-Rating for Vehicle

Vehicle Suspension "Ride"	g-rating
Passenger car - smooth roads	1
Vans - smooth or rough roads	6
Truck/ trailer - smooth roads	6
Truck/trailer- rough roads	15
Off-road vehicles	15
Rail freight cars	10

Impact-O-Graph Devices has a complete line of products for your transportation monitoring needs.

Visit us at: www.impactograph.com

g-Rating for lb/kilo

Package Weight (lbs.)	Weight (Kilo)	g-rating
Under 40 lbs.	Under 18 Kilo	70-150
40-100 lbs.	18-45 Kilo	60-80
Over 100lbs.	45-450 kilo	20-50

Selection will depend upon the sensitivities of object, packaging and modes of transportation.